

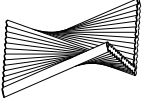

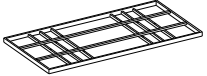

# ASSEMBLY INSTRUCTIONS

List of parts		
NO.	Description	Pcs
A		2
B		1
C		1
D		

step 1

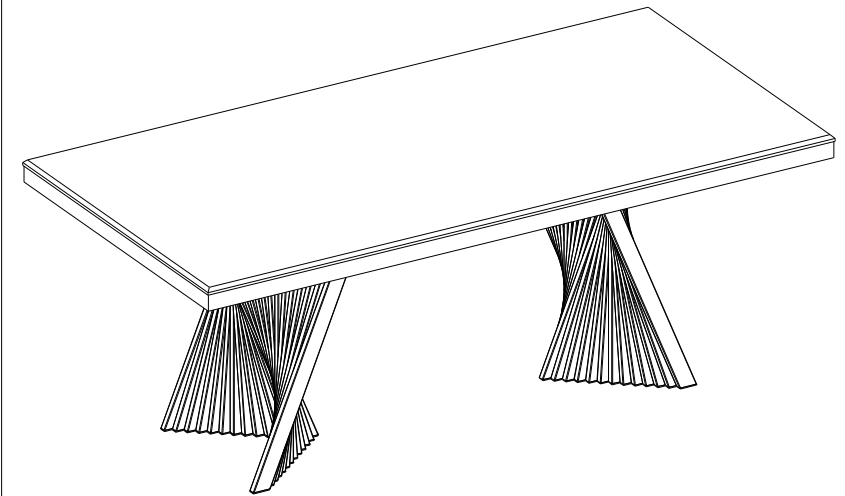
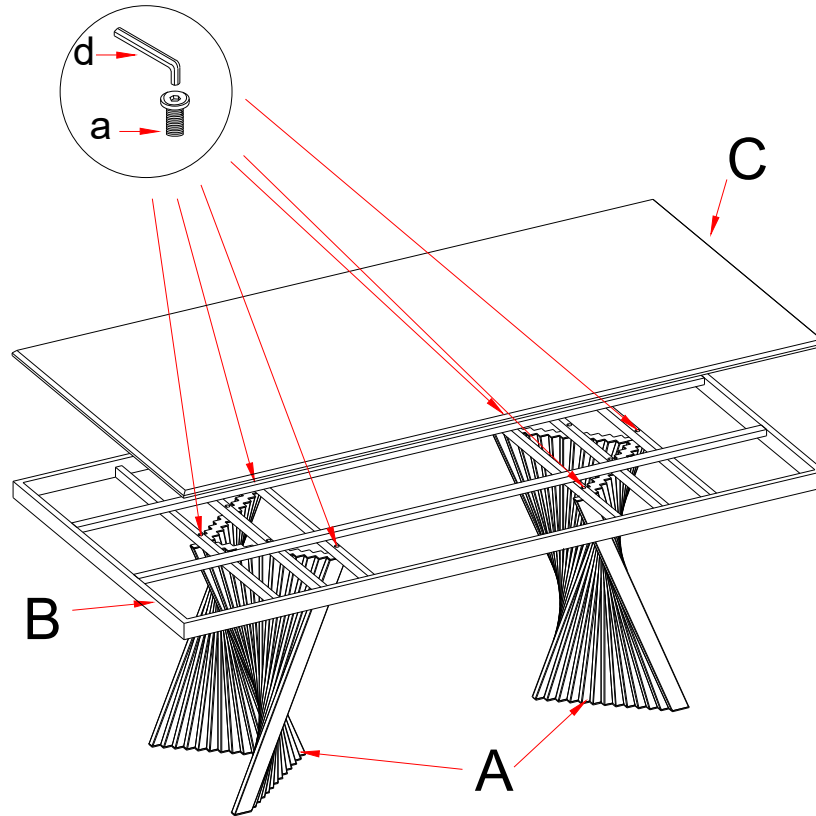
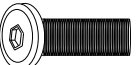

List of hardware			
NO.	Description	Qty	
a	 M8*30	6	
b			
c			
d		1	