

# ASSEMBLING INSTRUCTION

(1) ×1

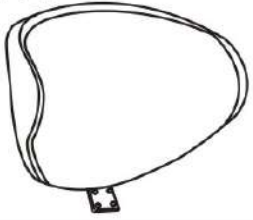

(6) ×4 6x16mm

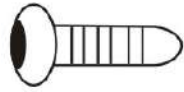

(2) ×1

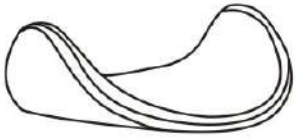

(7) ×4 6x20mm

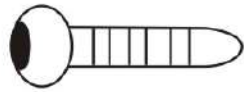

(3) ×1



(8) ×1

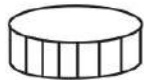

(4) ×1



(9) ×1



(5) ×1

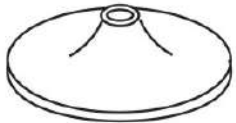

①

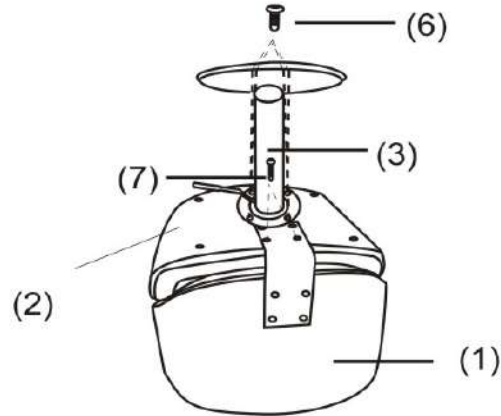

②

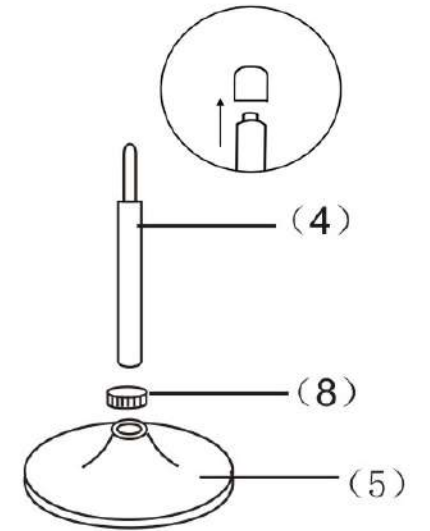

③

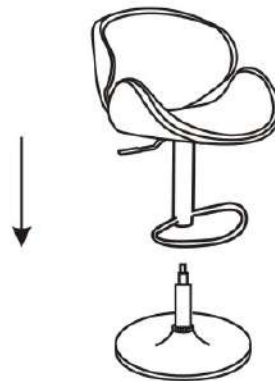

④

